

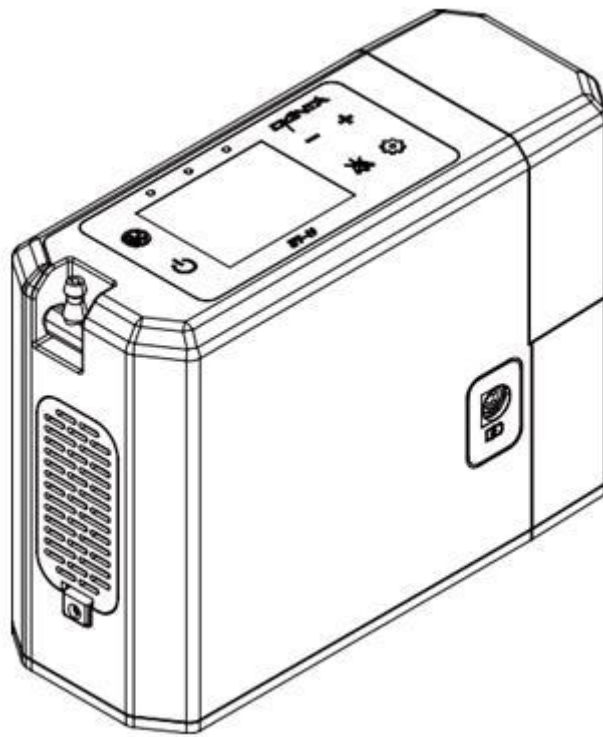

User Manual of Portable Oxygen Concentrator



DO NOT OPERATE THIS EQUIPMENT WITHOUT FIRST READING AND UNDERSTANDING THIS MANUAL.

Version: A / 2

Date: March 7, 2024

<https://www.cantamedical.com/products/>





Shenyang Canta Medical Tech. Co., Ltd.
Address: No.2-1 Puyu Road, Shenbei New District
110136 Shenyang, Liaoning Province
PEOPLE'S REPUBLIC OF CHINA

EC REP

MedNet EC-REP GmbH
Address: Borkstraße 10, 48163 Münster, Germany

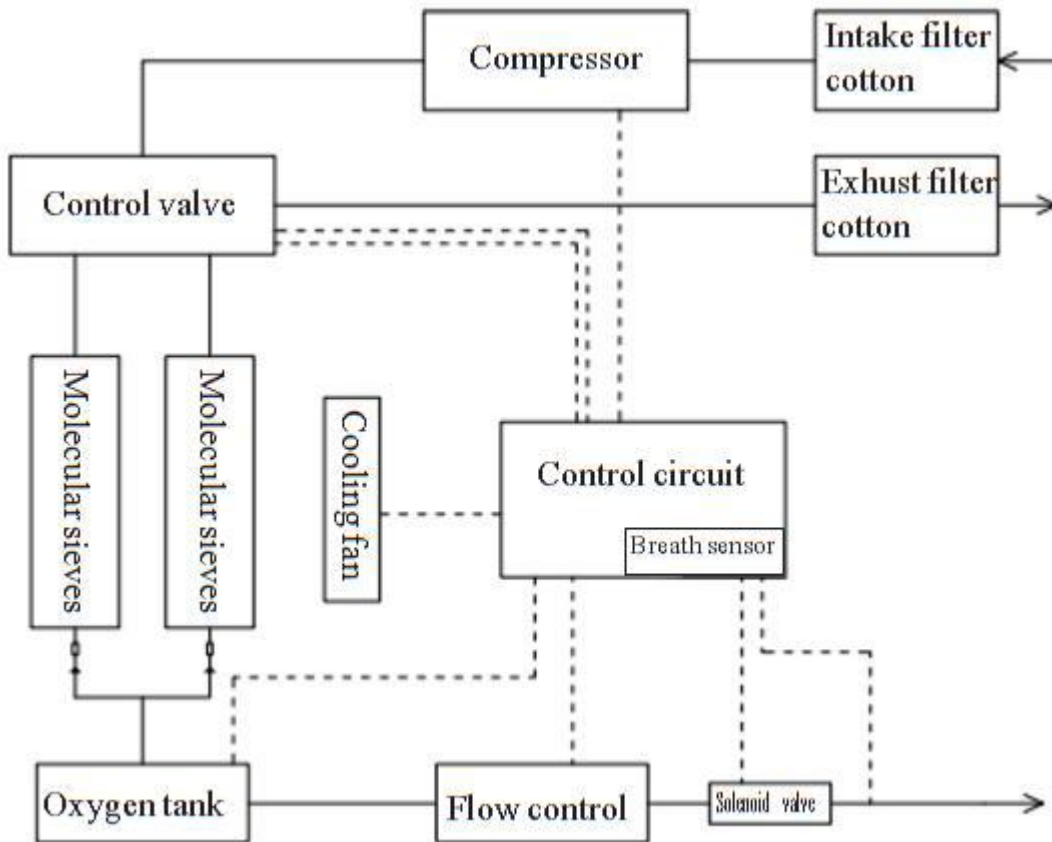

Contents

Safety notice.....	3
Attention.....	3
Product Introduction.....	4
Operating Environment.....	6
Transport and Storage Environment.....	7
Specifications.....	7
Symbols.....	8
Unit Components.....	9
User Control.....	11
Operating Instruction.....	11
Power Supplies.....	11
Maintenance.....	12
Alarm Indicators.....	12
Troubleshooting.....	13
Using lifetime.....	13
Accessories.....	14
Accessories Specification.....	15
Circuit Diagram.....	16
EMC Information.....	16

Foreword

Thank you for purchasing our products, hope you will be satisfied with our products.

This manual contains functions, operation steps, attention, technical specifications, trouble shooting and so on.

To ensure your efficient use of the machine, please have a close read of this operation manual before operating it.

Maybe there are some pictures which are different from what you have seen in the actual model.

Safety Notice

- This oxygen concentrator is suitable for users who have spontaneous breathing. Users who do not have spontaneous breathing or whose breathing is weak and cannot trigger pulses cannot use it.
- It takes 5 minutes for the oxygen concentrator to output the set flow rate and oxygen purity stably from the time it is turned on.
- The oxygen concentrator should be set to use in an environment without dust, corruption and toxicological harm gas.
- Put the portable oxygen concentrator in a well-ventilated position.
- The oxygen concentrator air inlet should be kept away from pollution and waste gas.
- When the oxygen concentrator status indicator indicates abnormal oxygen concentration levels, the operator should declare to the distributor or manufacturer for repairing.
- Disposable nasal oxygen cannula should be adopted under the requirements of provided products. If other types of disposable nasal oxygen cannulas are used, it should be ensured that they are closely and reliably connected with the oxygen concentrator. In order to avoid cross-infection, disposable nasal oxygen cannula should only be used by the person himself, and it should not be discarded after completion
- During oxygen therapy, there is a risk of ignition due to increased oxygen concentration. Oxygen concentrator should not be used near sparks or naked light.
- Before and during oxygen therapy, only water-based washing solutions or oils compatible with oxygen should be used. Do not use petroleum or oil-based detergents or oils to avoid the risk of fire.
- Oxygen concentrator spare parts, connectors, disposable nasal oxygen cannulas or other accessories should not be lubricated to avoid the risk of fire. The breathing system hoses may cause strangulation due to excessive length.
- Use adopt spare parts recommended by the manufacturer to ensure proper performance and avoid the risk of fire.
- Use outside the manufacturer's prescribed conditions will affect flow and oxygen level, it further affect treatment quality.
- Oxygen is combustion-supporting. When the oxygen concentrator is turned on and no one is inhaling oxygen, disposable nasal oxygen cannula should not be placed on the bedspread or chair cushion, because oxygen is easy to ignite under these materials. The oxygen concentrator should be turned off when not in use to avoid oxygen enrichment.

- If you feel uncomfortable or have a medical emergency during oxygen treatment, immediately seek medical help to avoid injury.
- When the elderly, or other patients are unable to express discomfort, additional monitoring measures or distributed alarm systems can be used to communicate discomfort and medical emergencies to the responsible caregivers to avoid injury.
- The device supplies high-concentration oxygen that promotes rapid burning. Do not allow smoking or open flames within the same room of this device, or any oxygen-carrying accessory. Failure to observe this warning can result in severe fire, property damage, and/or cause physical injury or death.
- Grease not recommended by the manufacturer cannot be used.
- Connect the device to a proper network power supply before the battery runs out of use.
- Do not place the device in a place where it is difficult to disconnect from the power supply. Unplug the power supply if not in use.
- Do not modify the equipment without authorization from the manufacturer.
- If cables and disposable nasal oxygen cannulas are too long, they may be wrapped around the neck and cause suffocation.
- Check the small parts on device regularly for loosen or not. Small parts that fall off the device may cause suffocation if swallowed by a child.
- Disposable nasal oxygen cannula are part of long-term exposure and may cause skin irritation.
- When the device runs for 5 minutes, but the air outlet can not feel the gas, it should be turn off immediately, and then check the fault.
- When starting the device, do not open the front and back case at will. If there are quality problems, customers are not allowed to disassemble maintenance, alarm and other abnormal phenomena should be contacted with distributors or manufacturers.
- This product is not intended for use in MR environment.
- The user and/or patient should report any serious incident that has occurred in relation to the device to the manufacturer and the competent authority of the Member State in which the user and/or patient is established.

The maintenance of the equipment is limited to the replacement of air filters and simple appearance cleaning, and disassembly is prohibited. Please contact professional maintenance staff if the equipment fails. Please contact the manufacturer or local distributor if need schematic diagrams and information on key components.

- When replacing the battery, please read the manual carefully. Careless operation may cause damage to the device.
- Adults who can correctly read and understand the instructions are suitable for using this device.
- After long-term use, the internal electrodes and sensor components of the equipment fail, resulting in insufficient equipment accuracy and the equipment cannot be used normally. Please contact the supplier.

Attention

- Oxygen output should be set individually for each patient, according to equipment and accessory configurations
- The position of the disposable nasal oxygen cannula in the nostrils and the direction of the air outlet determine the amount of oxygen delivered to the patient's respiratory system.
- Equipment maintenance is prohibited in use.
- The patient is the intended operator and all functions of the oxygen concentrator are available to the patients.
- All functions and maintenance mentioned in the manual can be performed by patients.
- This product is suitable for patients who need oxygen therapy, not for life maintenance; It is recommended that patients with aerobic therapy follow the doctor's guidance in choosing the flow rate and oxygen duration when using the device.
- Do not place the oxygen concentrator in an environment with strong magnetic field. Strong magnetic field may cause abnormal function to the oxygen concentrator.
- When the oxygen concentrator is not in use for a long time, please take out the battery and place it in a cool, dry and safe environment. Charge the battery regularly; otherwise, the service life of the battery may be affected.
- Disposal of medical devices should comply with local management regulations.
- The disposable nasal oxygen cannula is sterilized product. Please refer to the packaging of the disposable nasal oxygen cannula for details on the sterilization method. If the packaging of the disposable nasal oxygen cannula is found to be damaged before use, please do not use it.
- The manufacturer can provide circuit diagrams, list of components, drawing notes, and calibration details for maintenance personnel in order to repair the equipment upon request.
- The time required for the oxygen concentrator to be ready for its intended use from the lowest storage temperature after use to the ambient temperature of 20°C is 1 hour.
- The time required for the oxygen concentrator to be ready for its intended use from the highest storage temperature after use to the ambient temperature of 20°C is 10 minutes.
- Oxygen concentrator has intermittent exhaust sound when in use.
- Oxygen concentrator can not frequently start and stop: turn on after turn off, the interval shall not be less than 5 minutes, to prevent the air compressor with pressure start affect its lifetime.
- Please unplug the adapter after shutdown.
- Remove the power supply and battery before cleaning the dust from the oxygen concentrator to avoid electric shock.
- When used by different patients, a new disposable nasal oxygen cannula should be replaced, and the case of the device should be wiped with alcohol or water.
- If necessary, the operator can obtain relevant information on installation, use and maintenance from the supplier.

Product Introduction

Working principle: CANTA Portable Oxygen Concentrator use Pressure Swing Adsorption principle to separate the oxygen in the air from nitrogen and other gases. At normal temperature, connect with the power, it can be continuously separated $\geq 90\%$ purity of oxygen from air.

Structure and Composition: Portable oxygen concentrator consists of compressor, molecular sieve adsorption separation device, radiator, control board, AC power adapter, lithium ion battery pack, and disposable nasal oxygen cannula.

Features:

- ◇ Adopting brand micro oil-free compressor, stable working performance;
- ◇ Adopting the stretching process tank, automatically filling molecular sieve, reducing weight and prolonging service life;
- ◇ Good heat dissipation, the network power supply can work continuously for 24 hours and keep the oxygen purity stable.

Intended purpose: This product is mainly used for generating oxygen with purity not less than 90%, and is used to provide high purity oxygen to adults who are diagnosed as needing supplemental oxygen. It can be used in hospitals, homes and offices, not as life support equipment.

Contraindications: This device is not intended to be life-sustaining or life-supporting; This device is not intended for pediatric use; Smoking cigarettes while undergoing treatment, especially during treatment, is prohibited.

Intended patient population: The Portable Oxygen Concentrator is intended to be used for adults.

Intended user: The Portable Oxygen Concentrator is intended for use by medical staff and lay persons.

Operating Environment

Environment temperature scale: $-5^{\circ}\text{C} \sim 40^{\circ}\text{C}$

Comparative humidity scale: $15\% \sim 90\%$

Air pressure scale: $700 \text{ hPa} \sim 1060 \text{ hPa}$

Transport and Storage Environment

Environment temperature scale: $-25^{\circ}\text{C} \sim 70^{\circ}\text{C}$

Comparative humidity scale: $\leq 90\%$, Non-condensing

Air pressure scale: $700 \text{ hPa} \sim 1060 \text{ hPa}$











Specifications







Product name	Portable Oxygen Concentrator
--------------	------------------------------

Product model	HPT-10					
Sound	55dB(A)					
Preheat time	5min					
Oxygen concentration	$\geq 90\%$					
Rated flow	1L/min					
Flow setting and pulse volume	Gear setting pulse					
		1	2	3	4	5
	Breathing rate		Pulse volume(ml)			
	15	13	27	39	56	64
	20	12	20	29	42	50
	25	8	16	23	34	38
	30	7	13	29	28	32
	35	6	11	17	24	27
	40	5	10	15	21	24
IP Classification	IP21					
Breath rate	Max 40/ min					
Respiration sensor sensitivity	25Pa					
Max pressure of outlet port	40Kpa \pm 10%					
AC power	AC input :100-240V~ 50-60Hz					
DC power	DC input :DC19V 6.31A 120W					
Rechargeable Battery	Voltage:14.8V 6.4Ah 95Wh					
Usage mode	Continuous use					
Battery duration	Up to 4 hours					
Battery charging time	No more than 4 hours					

Net weight	1.95KG
Size	217*85*156mm
Shock proof type classification	ClassII
Shock proof degree classification	BF Application part
Note: The corresponding flow error of each gear is $\pm 15\%$	

Symbols

No.	Graphical symbols	Description
1		Date of manufacture
2		Authorized representative in the European Union
3		Serial number
4		Manufacturer
5		CE mark: indicates that the device complies with the EU 2017/745
6		Type BF applied part
7		Class II equipment
8		Operator's manual; operating instructions
9		Ingress protection
10		ENVIRONMENT PROTECTION - Waste electrical products should not be disposed of with household waste. Please recycle where facilities exist. Check with your local authority or retailer for recycling advice.

11		Caution: indicates the need for the user to consult the instructions for use for important cautionary information such as warnings and precautions that cannot, for a variety of reasons, be presented on the medical device itself.
12		Medical device
13		Unique device identifier
14		Fragile, handle with care
15		Keep dry
16		This way up
17		Stacking limit by number

Unit Components

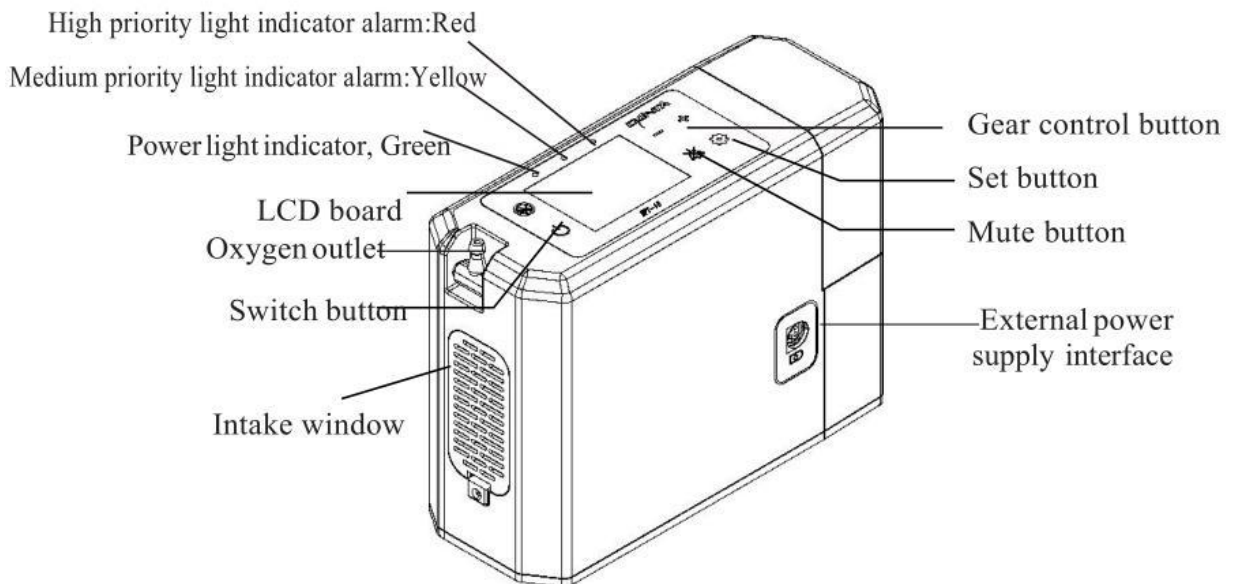

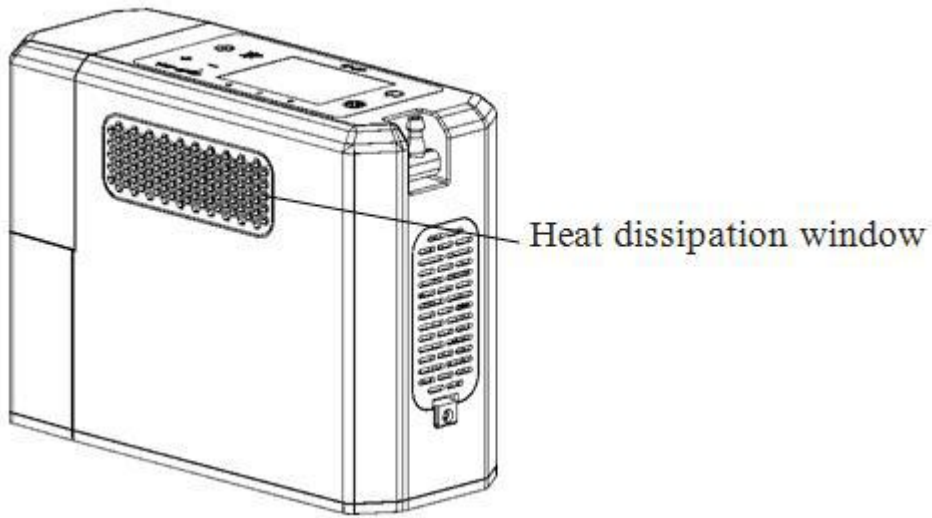



User Control

 Switch: Press for more than 1 second to start/stop function

 Mute: Temporarily turn off the button and alarm sound, the sound will be automatically restored after 10 minutes

 Gear control: Used to select the gear of pulse flow, you can view the current pulse flow gear on the display.

 Gear setting: Used to set some basic parameters of the device. The disposable nasal oxygen cannula is the applied part.

Press the setting button to enter the setting interface, the interface is as follows:

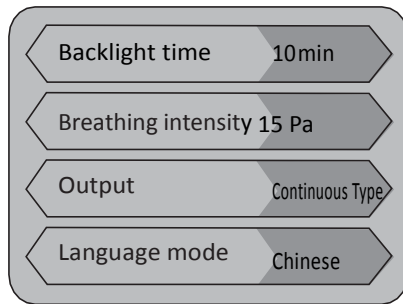
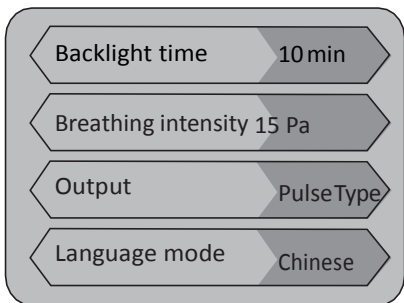

Press the setting key again to set the backlight time, breathing intensity, output mode and language selection in turn. When selecting a language option, press the setting key again to return to the main interface.

Backlight time: When the selected area is in the backlight time option, press the +/- key to switch the duration of the screen backlight after no operation (1 minute, 10 minutes, 30 minutes, 60 minutes and never extinguished)

Respiration intensity: When the selected area is in the breathing intensity option, press the +/- key to fine-tune the breathing detection intensity value (according to personal breathing intensity and feeling, adjust the value to pulse oxygen timely, accurate and good feeling).

Output mode: When the selection area is in the output mode option, long press the +/- key to set the output mode of the machine. The gear can be switched in pulse mode, and the rated output flow is in continuous mode, without gear switching.

Language selection: When the selection area is in the language selection option, press the +/- key to set the language of the machine

Operating Instruction

1. Locate the oxygen concentrator in appropriate position.
 - a. The oxygen concentrator should be in well-ventilated environment, so that the air inlet and air outlets are not obstructed.
 - b. Oxygen concentrators should be located in the position where can be easily heard or seen.
 - c. Make sure the air intake filter in matching position.If no air intake filter, please contact the supplier to ask for filter.
2. Assemble the battery into the oxygen concentrator.

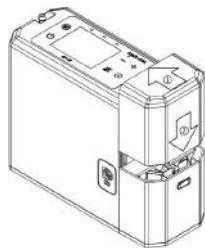

Battery installation: Put the battery in the slide rail, please follow direction of the arrow
Push the battery in the direction of the arrow until can hear a click, then the battery is seated

3. Connect the battery, the socket is located in the lower right corner of the device.

Caution: non-recommended nasal oxygen cannula may affect performance



4. Connect your cannula to the oxygen outlet, make sure the connection is firm before using.



5. Press the ON/OFF button for one second, and then start the oxygen concentrator. Press the buttons of increase (+) or decrease (-) to set the flow rate.

Each time you turn on the unit, a brief alarm sounds. This indicates that unit is powered for use.

Note: When using for the first time, its default pulse level suppose to be gear 5. If the pulse gear has been set, the device will remember gear setting before.

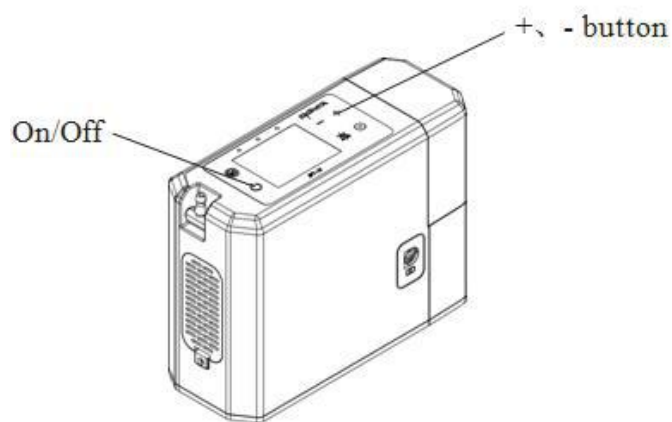

6. Put the nasal oxygen cannula according to the instructions from manufacturer, and then breathe normally.

When unit senses inhalation, oxygen is supplied to you through your cannula.

7. To change the pulse flow settings, press the button of increase (+) or decrease (-), it is normal to hear a difference in sound as you change the settings.

8. Press the ON/OFF button for one second to turn off the oxygen concentrator.

Power Supplies

This oxygen concentrator can be powered in two different ways:

- (1) Rechargeable battery pack
- (2) Adapter

Operation information please refer to the following sections.

Note: Please use power supply from original supplier and follow rules in user manual. Using a power supply or battery pack beyond original supplier, will result in equipment damage or malfunctioning.

Battery pack

This oxygen concentrator can support rechargeable battery pack. All functions and settings are available when using battery pack.



Battery installation

Slide the battery along the slide rail, push the battery down, and then can hear a click. That means the battery is ready. It confirms the lock in matching position.

Remove the battery

WARNING: Do not turn off the oxygen concentrator and disconnect the external power before removing the battery pack.

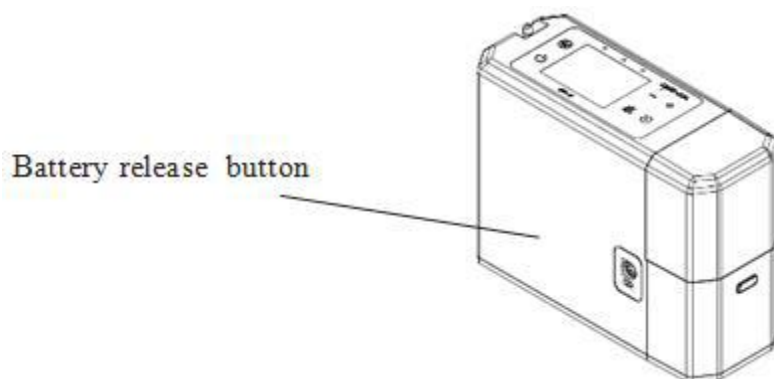

Press and hold the battery release button inward and then pull up to slide the battery pack out.

Check battery pack charge status

If want to check the status of the battery installed in the oxygen concentrator, referring to the battery icon and estimate value on the LCD.



General charging information

When the battery is installed in the oxygen concentrator and connected to an external power source, the oxygen concentrator will charge the battery pack without exception. When 100% displayed, the battery was fully charged.

The battery pack can also be charged by the cradle charger included in the accessory.

Battery Runtime

When the external AC or DC power supply is disconnected, If the oxygen concentrator installed with a charged battery,

the oxygen generator will automatically switch to battery power. The table below shows standard duration of a brand new battery.

The duration of the battery would not be changed according to your breathing rate.

Pulse setting	1	2	3	4	5
Runtime	4 hours	3 hours	2.5 hours	2 hours	1.5 hours

Standard battery recharge time

Standard charging time for a fully discharged battery pack,

About 3.5 hours for a single battery and 6.0 hours for a dual battery.

Note: If the battery pack is completely depleted, the battery may not initially charge.

Battery life

The oxygen concentrator battery is designed to complete 300 charge/discharge cycles.



AC power

The AC power supplied with your portable oxygen concentrator will power your oxygen concentrator wherever you are.

AC power includes the following:

1. AC power adapter, working power conditions are 100V-240V, 50Hz-60Hz.
2. The AC power cord is used to connect the AC power adapter and the corresponding AC socket.

AC power is used at home or any environment where a standard AC outlet is available. The portable oxygen concentrator is fully functional when powered by AC. The Portable Oxygen Concentrator can charge the battery pack whenever any AC power source is available (except in airplanes and cars).

The battery pack will be charged whether or not the portable oxygen concentrator was powered on

Portable oxygen concentrator and AC power connection:

1. Connect the AC power adapter to Portable Oxygen Concentrator

Connect to the power socket on the right side of the front. Make sure to insert for a firm connection



2. Connect the AC power cord and AC power adapter.

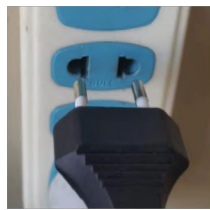

3. Plug the other end of the AC power cord into a wall outlet or other suitable power outlet.

Maintenance

Turn off the unit, clean the plastic housing periodically by wiping with a lint-free cloth or with a water-based washing liquid applied with a damp cloth or sponge.

1. Use no oil, grease, or petroleum-based or other flammable products with the oxygen-carrying accessories or the concentrator unit. Only water-based, oxygen compatible lotions or salves should be used. Oxygen accelerates the combustion of flammable substances.
2. Do not allow any liquid inside the machine.

Replace the nasal oxygen cannula

Nasal oxygen cannula should be replaced regularly. You can purchase nasal oxygen cannula from your doctor or supplier or follow the manufacturer's instructions.

Warning note:

1. The rated flow rate of oxygen in the nasal oxygen cannula is 5L/min to ensure the normal use of users.
2. If the nasal oxygen cannula package is damaged, do not use it. Please contact the equipment supplier in time.
3. Multiple people are prohibited to share the same nasal oxygen cannula to avoid cross infection.

Cleaning and replacement of intake window and intake filter cotton

The design of two intake windows on the front side of the oxygen concentrator can ensure sufficient air flow through the equipment.

Intake window:

Must be cleaned weekly to ensure adequate airflow through the equipment. Clean intake Windows with water and mild liquid detergent;

Ensure that the air intake window is dry before using it.

More frequent cleaning of intake Windows may be required for use in harsh conditions such as dust.



Intake filter cotton is designed to ensure that clean air enters the compressor:

- (1) Remove intake window
- (2) Remove the intake filter cotton from the intake chamber
- (3) Insert a new intake filter cotton
- (4) Install air intake window

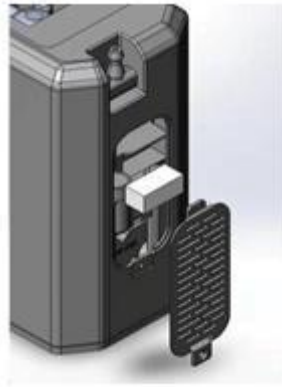
Intake filter cotton can be purchased from suppliers.



Alarm Indicators

Alarm status	Technical alarm					
Name of alarm	Low oxygen concentration alarm	High temperature alarm	Low pressure alarm	Low battery alarm	Network power alarm	Aitomatic mode
Alarm level	Medium	High	High	High	Medium	-
Alarm mode	Sound-light alarm					
Sound alarm	Beep- Beep- Beep	Beep- Beep- Beep- Beep- Beep- Beep- Beep- Beep- Beep	Beep- Beep- Beep- Beep- Beep- Beep- Beep- Beep- Beep	Beep- Beep- Beep	Beep- Beep	-
Alarm volume dB(A)	55	60	60	55	55	-
Visual alarm	The O_2 appears on the display. The purity alarm light flash	The  appears on the display. The faulty alarm light flash.	The P_i appears on the display. The faulty alarm light flash	The red  appears on the display. The power indicator flash	The  appears on the display.	No breathing is detected for 1 minute, the AUTO appears on the display
Alarm light color	Yellow	Red	Red	Yellow	-	-
Alarm delay	3s	3s	3s	-	-	-
Alatm presrt value	<82%	>46°C	≤1atm	Battery power ≤10%	Charging flashing Full bright	1 min

1. Low oxygen purity alarm: Turn off the oxygen concentrator and contact the manufacturer or service provider for repair.
2. Temperature alarm: turn off the oxygen concentrator and check whether the cooling port of the oxygen concentrator is well ventilated. After 30 minutes, turn it on again. If this alarm still occurs, please contact the manufacturer or service provider for repair.
3. Pressure fault alarm: turn off the oxygen concentrator, please contact the manufacturer or service provider for repair in time.
4. Low battery alarm: replace the battery or access the network power supply.
5. Alarm presets cannot be adjusted.
6. Users can perform alarm verification once a month. The verification method is: unplug the adapter connected to the power supply of the network, and the device emits two beeps, which proves that the alarm system is normal.
7. If the equipment is used in a separate area with the same or similar equipment at the same time, please do not confuse it with the alarm preset value of other equipment.

Troubleshooting

No.	Trouble	Causes	Solution
1	No operation after power connected	<ol style="list-style-type: none"> 1. Battery installed not correctly. 2. Battery power off 3. Power line installed not correctly 	<ol style="list-style-type: none"> 1. Remove the battery pack and reinstall it correctly 2. After replacing the battery or charging the battery, If the problem cannot be solved, please contact your equipment supplier 3. Check the power connection; check if the green indicator light is always on
2	No oxygen out	<ol style="list-style-type: none"> 1. The machine is not turned on 2. The disposable nasal oxygen cannula is twisted or blocked 3. Equipment failure 	<ol style="list-style-type: none"> 1. Turn on the portable oxygen concentrator 2. Check the disposable nasal oxygen cannula and its outlet connection at the connection port 3. Contact the equipment supplier
3	Low oxygen concentration	<ol style="list-style-type: none"> 1. The equipment is warming up 2. Molecular sieve may need repair 	<ol style="list-style-type: none"> 1. Wait for 5 minutes; if the problem still not resolved, please contact the equipment supplier 2. Please contact the equipment

			supplier for replacement of Molecular sieve
--	--	--	---

Using Lifetime

Design life of the whole machine: 10,000 hours or 2 years (whichever comes first)

Battery group: 300 full charge and discharge

Accessories

Portable oxygen concentrator 1 unit

User Manual 1 piece

Disposable nasal oxygen cannula 2 pcs

Quality certification 1 piece

Air intake filter cotton 20 pcs(for replacement)

Warranty Card 1 piece

Power Adapter 1 set

Lithium battery pack 2 pieces

Adapter power cord 1piece

Portable accessory bag 1piece

Portable bag 1piece

Accessories Specification

Disposable nasal oxygen cannula: π -type disposable nasal oxygen cannula from manufacturer who was medical device registration

Power adapter INPUT: AC100-240V~ 50/60Hz, OUTPUT: DC12V/6A

Lithium battery pack: 14.8V 6.4Ah 95Wh

Circuit Diagram

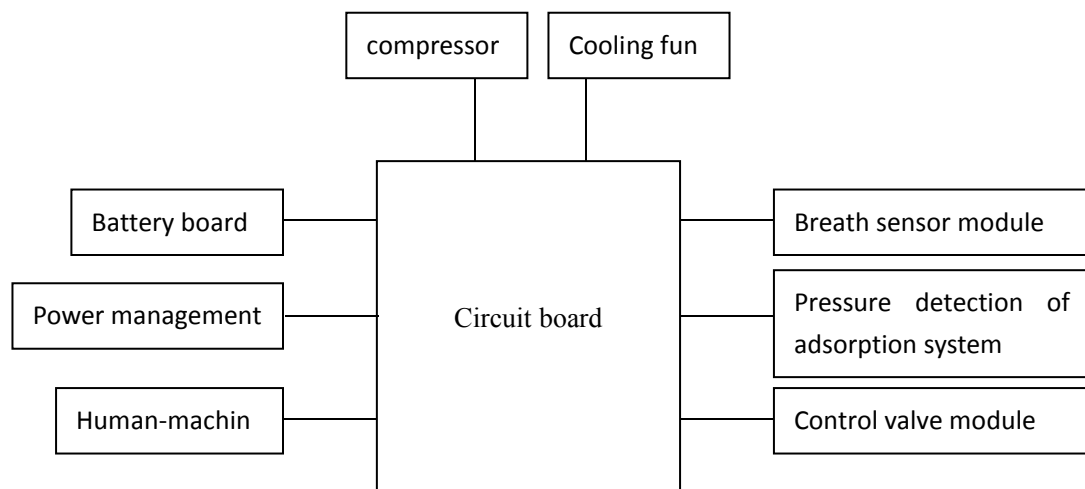

EMC Information

This equipment has been tested and found to comply with the limits for medical devices to the Electromagnetic Compatibility standard.

These limits are designed to provide reasonable protection against harmful interference in a typical medical installation. This equipment generates, uses, and can radiate radio frequency energy and, if not installed according with the instructions, may cause harmful interference to other devices.

However, there is no guarantee that interference will not occur in a particular installation. If this equipment does cause harmful interference will not occur in a particular installation. If this equipment does cause harmful interference to other devices, which can be determined by turning the equipment off and on, the user is encouraged to try to correct the interference by one or more of the following measures:

Reorient or relocate the receiving device.

n Increase the separation distance between the equipment.

n Connect the equipment into an outlet on a circuit different from that which the other device(s) are connected.

n Consult the manufacturer or service technician for help.

Guidance and Manufacturer's declaration-electromagnetic emissions

Is intended for use in the electromagnetic environment specified below. The customer or the user of the Turtle series should assure that it is used in such environment.

Guidance and Manufacturer's declaration-electromagnetic emissions		
The device is intended for use in the electromagnetic specified below. The customer or the user of the device should assure that it is used in such an environment.		
Emissions test	Compliance	Electromagnetic environment-guidance
RF emissions CISPR 11	Group 1	The device uses RF energy only for its inermalfunction. Therefore, its RF emissions are very low and are not likely to cause any interference in nearby electronic equipment.
RF emissions CISPR 11	Class B	The device is suitable for use in all establishments, including domestic establishments and those directly connected to the public low-voltage power supply network.
Harmonic emissions IEC 61000-3-2	Class A	
Voltage fluctuations/flicker emissions IEC 61000-3-3	Complies	

Guidance and Manufacturer's declaration-electromagnetic immunity			
The device image intended for use in the electromagnetic environment specified below. The user of the device image intensifier should assure that it is used in such an environment.			
Immunity test	IEC 60601 Test level	Compliance level	Electromagnetic environment-guidance
Electrostatic discharge(ESD) IEC 61000-4-2	±6 Kv contact ±8 Kv air	±6 Kv contact ±8 Kv air	Floors should be wood, concrete or ceramic tile. If floors are covered with synthetic material, the relative humidity should be at least 30%.
Electrical fast transient/burst IEC 61000-4-4	±2Kv for power supply lines	±2Kv for power supply lines	Mains power quality should be that of a typical commercial or hospital environment.
Surge IEC 61000-4-5	±1 kv line(s) to line(s)	±1 kv differential mode	Mains power quality should be that of a typical commercial or hospital environment.
Voltage dips, short interruptions and voltage variations on power supply input lines IEC 61000-4-11	<5%U _T (>95% dip in U _T)for 1.5 cycle 40%U _T (>60% dip in U _T)for 5 cycle 70%U _T (>30% dip in U _T)for 25 cycle <5%U _T (>95% dip in U _T)for 5 s	<5%U _T (>95% dip in U _T)for 1.5 cycle 40%U _T (>60% dip in U _T)for 5 cycle 70%U _T (>30% dip in U _T)for 25 cycle <5%U _T (>95% dip in U _T)for 5 s	Mains power quality should be that of a typical commercial or hospital environment. If the user of the device image intensifier requires continued operation during power mains interruptions, it is recommended that the device image intensifier be powered from an uninterruptible power supply.
Power frequency(50/60 Hz) magnetic field IEC 61000-4-8	3A/m	0.3 A/m	If image distortion occurs, it may be necessary to position the device image intensifier further from sources of power frequency magnetic fields or to install magnetic shielding. The power frequency magnetic field should be measured in the intended installation location to assure that it is sufficiently low.
NOTE: U _T is the a.c. mains voltage prior to application of the test level.			

Guidance and Manufacturer's declaration-electromagnetic immunity			
The device is intended for use in the electromagnetic environment specified below. The customer or the user of the device should assure that it is used in such an environment.			
Immunity test	IEC 60601 Test level	Compliance level	Electromagnetic environment-guidance
Conducted RF IEC 61000-4-6	3Vrms 150KHz to 80MHZ	3Vrms	Portable and mobile RF communications equipment should be used no closer to any part of the device, including cables, than the recommended separation distance calculated from the equation applicable to the frequency of the transmitter. Recommended separation distance $d=1.2\sqrt{P}$ $d=1.2\sqrt{P}$ 80MHz to 800 MHz $d=1.2\sqrt{P}$ 800MHz to 2.5GHz where P is the maximum output power rating of the transmitter in watts(W) according to the transmitter manufacturer and d is the recommended separation distance in metres(m). field strengths from fixed RF transmitters, as determined by an electromagnetic site survey, should be less than the compliance level in each frequency range. Interference may occur in the vicinity of equipment marked with the following symbol:  错误!
Radiated RF IEC 61000-4-3	3V/m 80MHz to 2.5GHZ	3V/m	
Note 1: at 80MHz and 800MHz, the higher frequency range applies. Note 2: these guidelines may not apply in all situations. Electromagnetic propagation is affected by absorption and reflection from structures, objects and people.			
a Field strengths from fixed transmitters, such as base stations for radio(cellular/cordless)telephones			

and land mobile radios, amateur radio, AM and FM radio broadcast and TV broadcast cannot be predicted theoretically with accuracy. To assess the electromagnetic environment due to fixed RF transmitters, an electromagnetic site survey should be considered. If the measured field strength in the location in which the Model 006 is used exceeds the applicable RF compliance level above, the Model 006 should be observed to verify normal operation. If abnormal performance is observed, additional measures may be necessary, such as re-orienting or relocating the Model 006.

b Over the frequency range 150kHz to80MHz, field strengths should be less than 3V/m.

Recommended separation distances between portable and mobile RF communications equipment and the device

The device is intended for use in an electromagnetic environment in which radiated RF disturbances are controlled. The customer or the user of the device can help prevent electromagnetic interference by maintaining a minimum distance between portable and mobile RF communications equipment(transmitters)and the devices as recommended below, according to the maximum output power of the communicatons equipment.

Rated maximum output power of transmitter	150 KHz to80 MHz $d=1.2 \sqrt{P}$	150 KHz to80 MHz $d=1.2$	150 KHz to80 MHz $d=2.3$